



OWNER'S MANUAL

HIGH WALL SPLIT INVERTER



(English) (KSHVD1S SERIES)

IMPORTANT

As with any product that has moving parts or is subject to wear and tear, it is **VERY IMPORTANT** that you maintain your air conditioner and have it regularly serviced. Accordingly, it is a condition of warranty cover for your air conditioner that you comply with all of the maintenance and service requirements set out in this Manual. Compliance with these requirements will prolong the life of your air conditioner. Further, it is also a condition of warranty cover that the Maintenance Schedule in the Manual is filled out (by signing and dating it in the places indicated) when the item is completed. **ANY FAILURE TO CARRY OUT THE REQUIRED MAINTENANCE AND SERVICING, AND ANY FAILURE TO FILL OUT THE MAINTENANCE SCHEDULE, WILL VOID YOUR WARRANTY.**

(For complete warranty terms, refer to the separate Warranty Booklet sold with the product. Alternatively, visit www.braemar.net.au to download the terms. Warranty terms are subject to property access and industry safety standards.)

OUTDOOR MODELS	INDOOR MODEL	CAPACITY COOL / HEAT
KCHV25D1S	KSHV25D1S	2.5 kW / 3.2 kW
KCHV35D1S	KSHV35D1S	3.5 kW / 3.8 kW
KCHV46D1S	KSHV46D1S	4.6 kW / 4.7 kW
KCHV52D1S	KSHV52D1S	5.2 kW / 5.8 kW
KCHV60D1S	KSHV60D1S	6.1 kW / 7.3 kW
KCHV70D1S	KSHV70D1S	7.0 kW / 8.0 kW
KCHV80D1S	KSHV80D1S	8.0 kW / 9.0 kW
KCHV90D1S	KSHV90D1S	9.4 kW / 10.3 kW

CONTENTS

MAIN COMPONENTS.....	2
INTRODUCTION & SAFETY	3-4
OPERATION	
REMOTE CONTROLLER.....	5
CONTROLLER LAYOUT.....	6
ON/OFF	6
MODE	6
FAN SPEED.....	7
CLOCK	7
TEMP	7
▲ / ▼ BUTTONS	7
X-FAN	7
TURBO	7
LIGHT	7
QUIET	8
TIMER SETTINGS.....	8
SWING UP / DOWN	8
SWING LEFT / RIGHT.....	8
I FEEL.....	9
SLEEP	9-10
LOCK FUNCTION	10
FAHRENHEIT / CENTIGRADE	10
ENERGY SAVING	10
8°C HEATING FUNCTION	10
WiFi FUNCTION.....	10
EMERGENCY OPERATION	11
WiFi INSTALLATION.....	11
ERROR DISPLAY.....	12
MAINTENANCE & SERVICE.....	13
MAINTENANCE SCHEDULE	14
OPERATION TIPS.....	15
TROUBLESHOOTING	16
WARRANTY & SERVICE.....	17

MAIN COMPONENTS

INDOOR UNIT

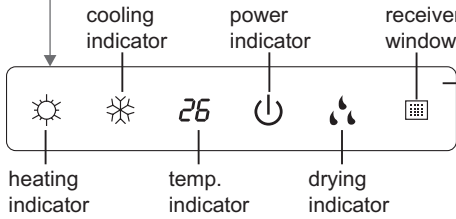
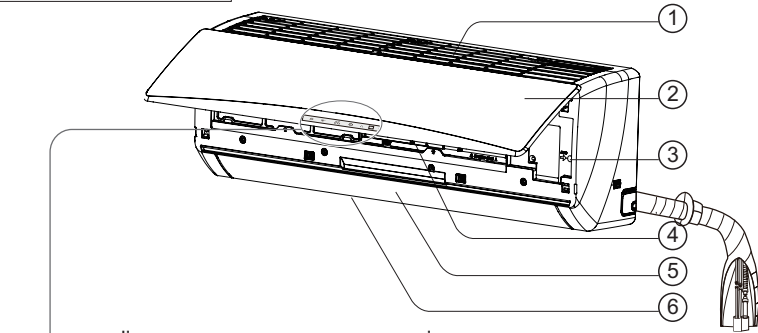

NOTE: Display panel style or position may differ from the above graphics.



8

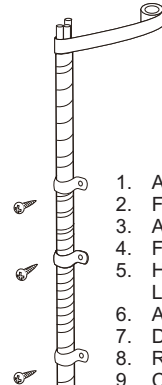

1. Air inlet
2. Front panel
3. Aux. button
4. Filter
5. Horizontal Louvre
6. Air outlet
7. Display panel
8. Remote control
9. Condensate tube
10. Gas Pipe
11. Liquid Pipe

OUTDOOR UNIT

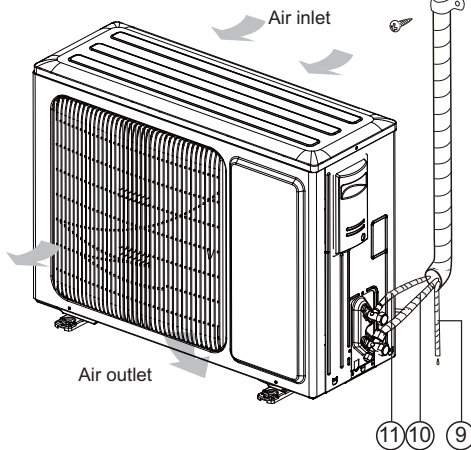

INTRODUCTION & SAFETY

Congratulations on purchasing a new Braemar Air Conditioner!

Please keep this Manual and the Warranty Booklet in a safe place, along with the original purchase documents, plus all relevant certificates of compliance relating to the installation work performed. Please register the Warranty straight away, by following the steps set out in the Warranty Booklet.

The installer must read the Installation Manual before installing the Braemar High Wall Inverter Air Conditioning Unit. The home owner/user should read the Owner's Manual before operating the Unit.

To ensure the warranty on the Unit is continued and valid, the Unit must be checked and serviced by the home owner/user as per the requirements in the Maintenance & Service section and the Maintenance Schedule. This will also prolong the life of your air conditioner.

The home owner/user should regularly check the Air Inlet side of the Outdoor unit (see the diagram on page 2) to ensure grass, leaf and other matter are not drawn into or onto the Inlet side of the Outdoor unit. Restriction to the air flow across the coil will reduce the system's capacity, and result in high operation pressures and excessive operating costs.

IMPORTANT!

THE AUSTRALIAN GREENHOUSE OFFICE HAS ISSUED VARIOUS REGULATIONS ON THE USE AND DISPOSAL OF REFRIGERANTS IN THE UNIT. FAILURE TO FOLLOW THESE REGULATIONS MAY HARM THE ENVIRONMENT AND COULD LEAD TO THE IMPOSITION OF SUBSTANTIAL FINES.

WHERE SPECIFIED, ONLY QUALIFIED AND LICENSED TECHNICIANS SHOULD PERFORM WORK ON THIS UNIT, FAILING WHICH THE WARRANTY ON THE UNIT WILL BE VOID.

WARNING! This appliance is not intended for use by persons (including children) with reduced physical, sensory or mental capabilities, or lack of experience and knowledge, unless they have been given supervision or instruction concerning use of the appliance by a person responsible for their safety.

Children should be supervised to ensure that they do not play with the appliance.

If the supply cord is damaged, it must be replaced by the manufacturer, its service agent or similarly qualified persons in order to avoid a hazard.

SAFETY cont.



Appliance filled with flammable gas R32.



Before using the appliance, read the owner's manual first.



Before installing the appliance, read the installation manual first.



Before repairing the appliance, read the service manual first.

REFRIGERANT

For product efficiency, a special refrigerant R32 is used in the air conditioner. Compared to common refrigerants, R32 is a non-polluting refrigerant which will not harm the ozone layer and has a much lower greenhouse potential. This refrigerant is flammable and odorless. The flammability is very low and can only be ignited by an open flame. However under certain conditions it can explode.

WARNING

Do not use means to accelerate the defrosting process or to clean, other than those recommended by the manufacturer.

The appliance shall be stored in a room without continuously operating ignition sources (for example: open flames, an operating gas appliance or an operating electric heater). It shall be stored in a well-ventilated area where the room size corresponds to the room area as specified for operation (refer Installation manual).

WARNING

Do not pierce or burn.

Be aware that refrigerants may not contain an odour.

Before any servicing on the air conditioner, the service manual should be read and understood by service personnel. Servicing shall be performed only as recommended in the service manual. Any repairs carried out by unqualified personnel may be dangerous.

OPERATION

Your Braemar High Wall Inverter Air Conditioning Unit has been designed and built with reliable, quality components. To ensure many years of trouble free, dependable service please read the following pages very carefully, and please ensure that you follow all of the instructions.

REMOTE CONTROLLER

Please follow the below cautionary notes when using the remote controller:-

1. Ensure there are no obstructions between the High Wall receiver and remote controller.
2. Don't let the remote control drop onto hard surfaces or be subjected to sudden shocks in any way. Don't allow the remote control to get wet. The warranty does not cover misuse or accidental damage.
3. Don't place the remote control in direct sunlight, or near extremes of temperature. This will affect the control's temperature reading.
4. Don't place near strong electromagnetic waves.
5. Don't mix old and new batteries! If the remote control will not be used for a long time, remove the batteries to avoid corrosion.
6. Before operating the air conditioner, please read this manual carefully and keep it in a safe place for future reference.

NOTE: This is a generic remote control, used for multiple types of air conditioner. Not all functions shown on the remote control may be operational for this unit.

CHANGING BATTERIES

Push down on the battery panel to open the battery compartment area.

Insert 2 x AAA 1.5V batteries, ensuring the polarity aligns with the markings in the battery compartment (refer below).

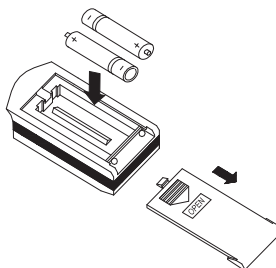

If the remote controller does not activate, remove the batteries and re-insert after waiting 30 seconds.

OPERATION cont.

CONTROLLER LAYOUT

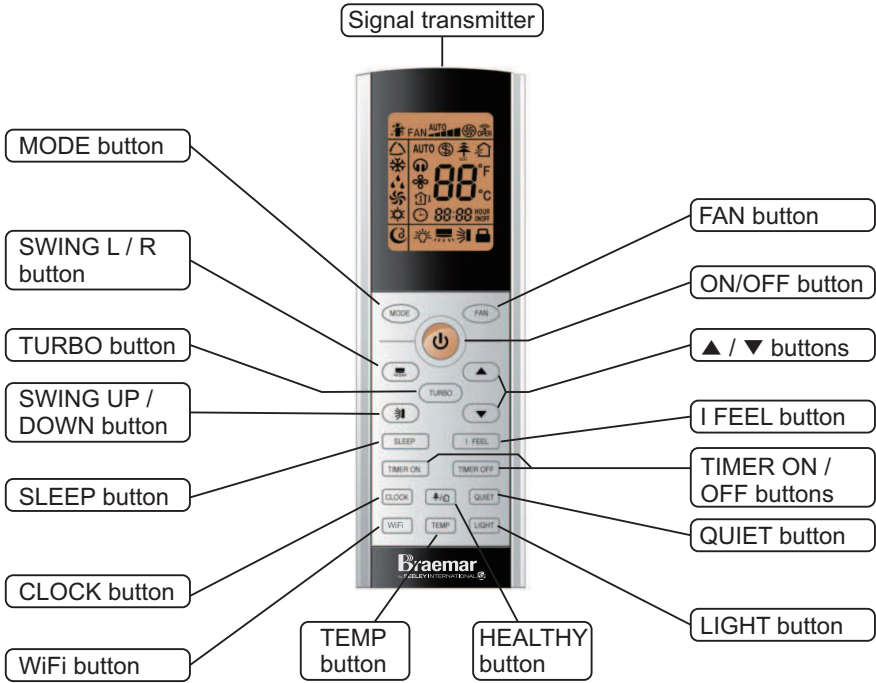

ON / OFF



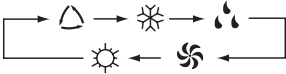

Press to turn the power on or off. SLEEP function will be cancelled when power is turned off.

MODE

Press to toggle between AUTO, COOL, DRY, FAN and HEAT modes. The remote controller & indoor will display the below icons:-



MODE cont.

-  AUTO Mode - cycles between COOL and HEAT modes depending on ambient temperature.
-  COOL Mode - refrigerated cooling
-  DRY mode - for extracting moisture from the air.
-  FAN mode - Fan only operation (no cooling).
-  HEAT mode - reverse cycle heating. NOTE: unit will delay 1-5 minutes to prevent cold air being circulated.

OPERATION cont.

FAN SPEED

Press the FAN button to toggle between AUTO, Low, Medium-Low, Medium, Medium-High and High speed.

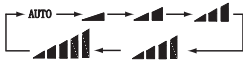

AUTO fan speed is default on power up. In DRY mode, only Low FAN speed is selected.

CLOCK

Press the CLOCK button to set the clock time. ☀ will flash on the display, and the clock can be adjusted by pressing the ▲ or ▼ buttons. Once the correct time is set, press the CLOCK button again to confirm the clock setting. ☀ will be displayed continuously, this indicates the clock time is set. '12:00' is the default setting after power up. Set the correct time to enable the TIMER function to work correctly.

TEMP

Press the TEMP button to toggle between the following on the indoor display:-

- SET temperature (room target temperature)
- Indoor ambient temperature
- Outdoor ambient temperature (when equipped)

Note: remote controller will always display the SET temperature.

▲ / ▼ BUTTONS

Use to adjust the SET temperature within the range 16-30°C (61-86°F). Hold the button down for quick adjustment.

Note: TEMP adjustment is unavailable in AUTO mode.

X-FAN

The X-FAN function can be used in COOL or DRY modes, so as to continue operation of the indoor fan for an additional 10 minutes after the power is turned off (so as to remove excess moisture from the indoor coil). Press the Fan speed button for 2 s. The ⚙ icon will be displayed. Repeat this to turn X-FAN off.

Default setting is X-FAN 'OFF', and is not available in AUTO, FAN or HEAT modes.

TURBO

When the unit is first turned on in COOL or HEAT modes, press TURBO to quickly reach the SET temperature. ⚙ icon will be shown on the remote controller display. TURBO mode is cancelled if MODE or FAN speed is changed.

LIGHT

Press the LIGHT button to toggle between LIGHT ON and LIGHT OFF status. Default is LIGHT 'ON'.

OPERATION cont.

QUIET



QUIET function can be employed to use lower fan speeds to attain the SET temperature when in AUTO, COOL and HEAT modes. The  icon will be displayed.

Note: QUIET function cannot be set in FAN or DRY modes. Fan speed cannot be changed when QUIET mode is set. Default is QUIET mode 'OFF'.

TIMER SETTINGS

The unit can be programmed to turn on, turn off or a combination of both when in standby or power ON modes. Use the below settings.

TIMER ON

Press the TIMER ON button to enter the setup. The  icon will disappear and "ON" will blink on the remote controller display. Use the  or  buttons to adjust the clock time for the unit to start. Holding these buttons will produce rapid adjustment.



When complete, press the TIMER ON button again to set.

Pressing the TIMER ON button again will CANCEL the TIMER ON function.

TIMER OFF

Press the TIMER OFF button to enter the setup. The  icon will disappear and "OFF" will blink on the remote

TIMER OFF cont.

controller display. Use the  or  buttons to adjust the clock time for the unit to stop. Holding these buttons down will produce rapid adjustment.

When complete, press the TIMER OFF button again to set.

Pressing the TIMER OFF button again will cancel the TIMER OFF function.

SWING UP / DOWN

Press to adjust the UP/DOWN louvre, each press will toggle between the below settings:-



Where a single line indicates a fixed position, multiple lines indicate swinging up/down in the positions shown.

If the louvre is set to OFF when swinging, it will remain fixed in the last position.

SWING LEFT / RIGHT

Press to adjust the LEFT/RIGHT louvre, each press will toggle between the below settings:-

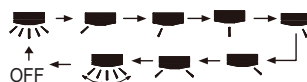

OPERATION cont.

I FEEL

Press the I FEEL button to activate this feature. The remote controller will act as the temperature thermostat, sending a temperature reading to the unit every 10 minutes. By this method, the unit will react to where the remote controller is positioned. The  icon will be shown on the remote controller display.

Press the I FEEL button again to **cancel** this feature.

SLEEP

Press SLEEP button to toggle between the SLEEP modes and cancel, as described below. Default setting is SLEEP mode 'OFF':-

SLEEP 1: In COOL and DRY modes, after running for one hour, the main unit SET temperature will increase by 1°C, then after 2 hours will increase by 2°C, then will continue to run at this temperature.

In HEAT mode, the SET temperature will decrease by 1°C and then 2°C for the first 2 hours, and then stay constant.

SLEEP 2: In COOL mode, the SET temperature will vary according to the below scenarios:-

a) If SET temperature starts between 16-23°C, SET temperature will increase by 1°C every hour for 3 hours, then stay constant until 7 hours

SLEEP cont.

has elapsed. It will then be decreased by 1°C, then will continue to run at this temperature.

b) If SET between 24-27°C, SET temperature will increase by 1°C every hour for 2 hours, then stay constant until 7 hours has elapsed. It will then be decreased by 1°C, then will continue to run at this temperature.

c) If SET between 28-29°C, SET temperature will increase by 1°C for 1 hour, then stay constant until 7 hours has elapsed. It will then be decreased by 1°C, then will continue to run at this temperature.

d) If SET at 30°C, SET temperature will stay constant until 7 hours has elapsed. It will then be decreased by 1°C, then will continue to run at this temperature.

In HEAT mode:-

a) If SET at 16°C, it will remain at this temperature.

b) If SET between 17-20°C, SET temperature will decrease by 1°C for 1 hour, then will continue to run at this temperature.

c) If SET between 21-27°C, SET temperature will decrease by 1°C for 2 hours, then will continue to run at this temperature.

OPERATION cont.

SLEEP cont.

d) If SET between 28-30°C, SET temperature will decrease by 1°C for 3 hours, then will continue to run at this temperature.

SLEEP 3: this is a User programmable curve, created as follows:-

a) When in SLEEP 3 mode, hold the TURBO button down until the remote displays '1 hour' and the SET temperature will display.

b) Adjust the SET temperature, then press TURBO button to confirm.

c) The remote display will move to the next time setting ('2 hours', '3 hours' or '8 hours'), and the SET temperature can again be programmed.

d) Repeat until the '8 hours' SET temperature has been entered. Once completed, the remote display will show the original settings.

The SLEEP 3 settings will be stored and can be reviewed at any time in the SLEEP 3 mode by pressing the TURBO button and scrolling through without adjusting the settings.

Review mode will be quit if no button is pressed within 10 seconds, or if the ON/OFF, MODE, TIMER or SLEEP buttons are pressed.

LOCK

The remote controller can be locked from inadvertent button operation. Press both ▲ or ▼ buttons

simultaneously to lock (or unlock) the remote controller. The  icon will be displayed, and will flicker when a button is pressed.

FAHRENHEIT / CENTIGRADE

The temperature display can be toggled between Centigrade and Fahrenheit scales by pressing the MODE and ▼ buttons simultaneously.

ENERGY SAVING

When in COOL mode, press the TEMP and CLOCK buttons simultaneously to start Energy Saving function. The remote controller display will show the 'SE' icon. Repeat to cancel.

8°C HEATING FUNCTION

When in HEAT mode, press the TEMP and CLOCK buttons simultaneously to start 8°C Heating function. The remote display will show  and a selected temperature of '8°C' (46°F). Repeat to cancel.

WiFi FUNCTION

Press the WiFi to toggle WiFi function on or off. The "WiFi" icon will appear on the remote control display when in use.

To restore factory default settings on the WiFi module, press "MODE" and "WiFi" buttons simultaneously for 1s when the unit is OFF.

OPERATION cont.

EMERGENCY OPERATION

If the remote controller is lost or damaged, you can use the 'auxiliary' button to turn on or off the air conditioner. Open the front panel, press aux. button to turn on (or off) the air conditioner. Air conditioner will operate in AUTO mode.

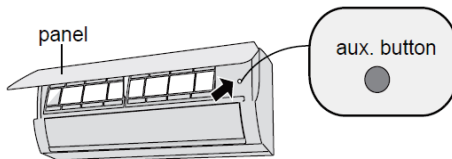

WARNING: Use an insulated object to press the aux. button.

WiFi INSTALLATION

OPERATING SYSTEMS

Requirements for User's smart phone:



iOS system
Support iOS7.0 and above version



Android system
Support Android 4.0 and above version

DOWNLOAD AND INSTALLATION

Scan the QR code or search 'Ewpe smart' from the application market to download and install it. When "Ewpe Smart" app is installed, register the account and add the device to achieve long distance control and LAN control of smart home devices. For more information, please refer to "Help" in the App.



App Download Linkage

CONTROL FLOW CHART

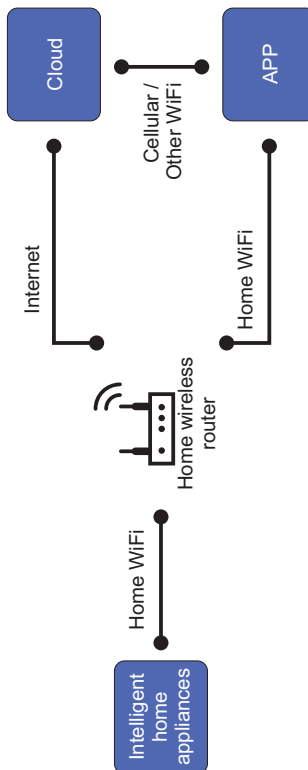

OPERATION cont.

ERROR DISPLAY

Your High Wall air conditioner includes abnormal operation detection hardware and software. If the unit enters an abnormal state, the temperature indicator on the fascia display will blink to display a corresponding error code.

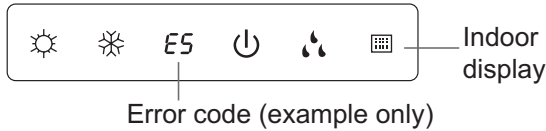

Common error codes and their meanings are shown below:

Error Code	Error Description
E1	It can be reset by restarting the unit. If not, please contact Seeley qualified service agents.
E5	It can be reset by restarting the unit. If not, please contact Seeley qualified service agents.
E8	It can be reset by restarting the unit. If not, please contact Seeley qualified service agents.
H6	It can be reset by restarting the unit. If not, please contact Seeley qualified service agents.
d1, d2, d3	DRED mode 1 (full shut down), mode 2 (50% power) or Mode 3 (75% power) signal received from Power Grid

Note: if there are other error codes displayed, please contact Seeley qualified service agents for details.

Please note the error code displayed when contacting Seeley service.

FAULT CONDITIONS

If the below conditions should occur, please turn off the air conditioner and isolate its power immediately, and then contact the Seeley qualified service agents for assistance.

- Power cord is overheating or damaged.
- Abnormal sound during operation.
- Circuit breaker is continually tripping.
- Burning smell is noticed.
- Indoor unit is leaking condensate

MAINTENANCE & SERVICE

SAFETY

Always isolate power for the air conditioner from electricity mains before cleaning or maintenance.

AIR FILTER

It is important to check and clean the air filter as per the Maintenance Schedule. A dirty air filter will not allow the correct amount of clean air to pass through your air conditioner, resulting in poor performance and increased running costs. Please follow the below steps:-

1. Pull the front panel out and up from the bottom as shown.

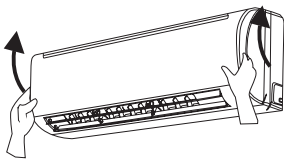

2. Remove the air filter and clean with a vacuum cleaner. If it is very dirty, wash with mild soapy water (below 45°C) and wipe off. Dry in the shade.

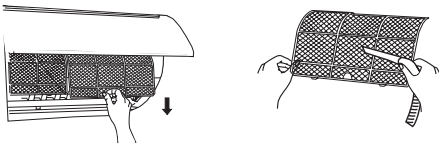

3. Make sure it is completely dry before refitting it. You should never operate the air conditioner without the air filter in place.

INDOOR COIL (REFER PAGE 2)

Ensure drain connections are checked on an annual basis (as set out in the Maintenance Schedule below). Drains can become blocked by all types of insects, and rats have been known to chew through the drain to get to the water in the pipe.

OUTDOOR UNIT (REFER PAGE 2)

The Outdoor unit has either one or two fans, it draws air through the appliance to expel the heat generated during the cooling cycle. We recommend checking that plants haven't grown into or around the air intake or outlet, along with other debris that may build up over time, namely, leaves and the like.

REFRIGERANT

A lack of refrigerant, due to a leak, will cause the compressor to overheat and expire prematurely. You will notice a decline in cooling effect and an increase in power consumption. Therefore, having a qualified, licensed technician service your air conditioner will save you money in the long term.

PLEASE REFER TO THE NEXT PAGE FOR THE MAINTENANCE SCHEDULE

MAINTENANCE SCHEDULE

Installation Date:	/	/	Installer:	
--------------------	---	---	------------	--

Items to be done by the Home Owner/User (please sign in the places indicated)							
	Monthly	Annually	Year 1	Year 2	Year 3	Year 4	Year 5
Air filter cleaning	✓						
Air filter replacement		✓					
Maintain required clearance around Outdoor unit		✓					

Items to be done by a Qualified Licensed Technician (Home owner/user must ensure that the technician signs and dates in the places indicated)	
	Annually
Check, clean or replace filter	✓
Check drain from indoor coil	✓
Check Outdoor unit clearances – maintain garden and debris	✓
Check refrigerant charge	✓
Check refrigeration connections for soundness	✓
Check outdoor fans	✓
Check electrical connections	✓
Check overall installation	✓
Report to the home owner/user all tasks that require attention	✓

Year 1 – Date:	/	/	Technician:	
Year 2 – Date:	/	/	Technician:	
Year 3 – Date:	/	/	Technician:	
Year 4 – Date:	/	/	Technician:	
Year 5 – Date:	/	/	Technician:	

Please NOTE: the Maintenance Schedule covers Year 1 to Year 5. To preserve your investment for many years afterwards, we strongly recommend that you continue to maintain and service the Braemar Cassette Inverter Air Conditioning Unit as per the items and frequency set out in the Schedule, and as indicated elsewhere in this Manual.

OPERATION TIPS

The following events may occur during normal operation:

1. Protection of the air conditioner.

Compressor protection

- The compressor cannot restart for 3 minutes after it stops.
- The supply air drops below a pre-determined set point; this prevents the indoor coil from freezing.

2. A white mist coming out from the Indoor unit.

- A white mist may generate due to a large temperature difference between air inlet and air outlet on COOL mode in an indoor environment that has a high relative humidity.

3. Low noise of the air conditioner.

- You may hear a low hissing sound when the compressor is running or has just stopped running.

This sound is the sound of the refrigerant flowing or coming to a stop.

- You can also hear a low “squeak” sound when the compressor is running or has just stopped running.

This is caused by heat expansion and cold contraction of the plastic parts in the Unit when the temperature is changing.

4. Dust is blown out from the Indoor unit.

This is a normal condition when the air conditioner has not been used for a long time or during first use of the Unit.

5. A peculiar smell comes out from the Indoor unit.

This is caused by the Indoor unit giving off smells permeated from building material, from furniture or smoke (for example if someone is cooking food).

6. FAN operation during COOL mode.

When indoor air temperature reaches the setting on the remote controller, the compressor will stop operating and after approximately 60 seconds the indoor fan will stop blowing air. When the room temperature rises back to the set point, the indoor fan and the compressor will start again.

TROUBLESHOOTING

Problem	Probable Cause	Remedy
1. The air conditioner does not run.	1.1 Power failure. 1.2 Fuse blown or circuit breaker open. 1.3 Thermostat adjustment too low (in heating mode) or too high (in cooling mode).	1.1 Wait for power to resume. 1.2 Replace the fuse or reset the breaker. 1.3 Check thermostat setting. Is remote in a cold (COOL mode) or hot (HEAT mode) location.
2. Remote controller is not operating the air conditioner.	2.1 Remote controller is out of range. 2.2 Poor signal reception. 2.3 No display on remote controller.	2.1 Signal range is 8m. 2.2 Remove obstacles and electrical interference. 2.3 Check batteries and replace as needed.
3. There is insufficient cooling.	3.1 The room was probably very hot when you started the system. 3.2 Air filter is dirty / blocked.	3.1 Wait a while so the Unit has enough time to cool the room. 3.2 Clean the filter.
4. 'Clicking' sound is heard from the air conditioner.	4.1 In heating or cooling operation any plastic parts may expand or shrink due to a sudden temperature change in this event, a clicking sound may occur.	4.1 This is normal.
5. SET temperature can't be adjusted.	5.1 Unit is operating in AUTO mode. 5.2 The required SET temperature is outside of the allowable range.	5.1 Temperature cannot be set in AUTO mode. 5.2 SET temperature range is 16-30°C
6. Cooler is not operating at full power, or at all	6.1 DRED (Demand Response energy saving) mode has been activated by the Electricity Supplier.	6.1 DRED will stop grid power demands are reduced

WARRANTY & SERVICE

For prompt, efficient service, please follow the above before calling the appropriate number below.

For Refrigerated Cooling Issues

1300 526 477

When calling the Warranty Service number, please ensure you have your model and serial number available, along with date of purchase, and if possible a description of the problem.

NOTE:

Seeley International strives for continuous product improvements, therefore specifications are subject to change without notice. Unit colour may vary slightly from that depicted in this booklet.

Installation and commissioning of this system to the manufacturer's specification, and compliance with industry standards, and local, state and national regulatory codes, are the responsibility of the installer.

Information in this booklet was true and correct at the time of publishing. E & OE.

It is the policy of Seeley International to introduce continuous product improvements. Accordingly, specifications are subject to change without notice. Please consult with your dealer to confirm the specifications of the model selected.



Warranty Service
Refrigerated Cooling 1300 526 477
seeleyinternational.com

Braemar
By **SEELEY INTERNATIONAL** 
seeleyinternational.com